

Poltroncina con scocca in polipropilene o rivestita e base a slitta in acciaio verniciato

Armchair with polypropylene or upholstered shell and sled base in varnished aluminium

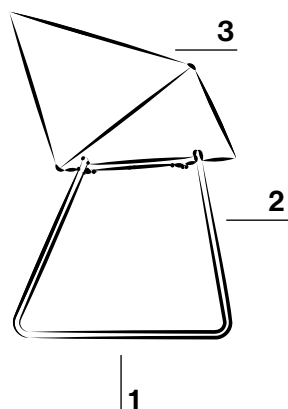
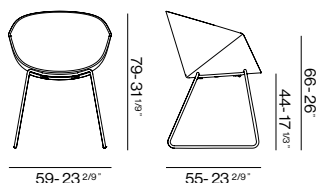

1. Base con inserto in polipropilene per pavimenti duri o delicati
Base with polypropylene insert for hard or delicate floors
2. Struttura metallica in filo di ferro trafilato crudo lucido FE 360 B, Ø 12 mm con percentuale media di ferro riciclato del 26,07%. Telaio verniciato a polveri termoindurenti a base di resine poliesteri per la prevenzione della proliferazione microbica
Metal structure in polished raw drawn iron wire FE 360 B, Ø 12 mm with an average percentage of recycled iron of 26,07%. Thermosetting powder-coated frame based on polyester resins to prevent microbial proliferation
3. Scocca in polipropilene provientente al 70% da riciclo post industriale
Polypropylene shell from 70% post-industrial recycling

FINITURE FINISHES

SCocca SHELL

Polipropilene Polypropylene



IG AN NG CB WR PG DG NB

STRUTTURA FRAME

Verniciato a polvere Powder coated



IG AN NG CB WR PG DG NB GO BR

DETTAGLI SPEDIZIONE SHIPMENT DETAILS

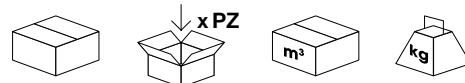

1 1pz 0,35m³ 9kg

Levante

VERSIONE SCOCCA SHELL VERSION

Polipropilene

Polypropylene

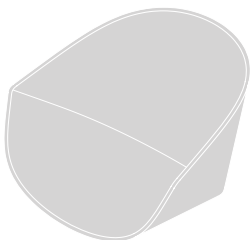

Polipropilene con cuscino fisso

Polypropylene with fixed cushion

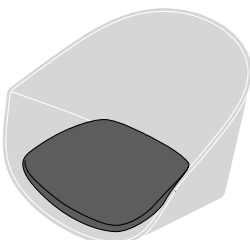

Tessuto cliente: necessaria approvazione di m | artedesign
Fabric supplied by customers: must be approved by m | artedesign



1 ml



1,4 mq

Rivestita totale

Fully upholstered

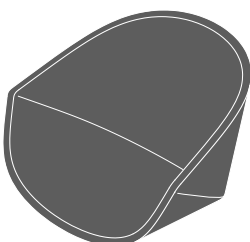

Tessuto cliente: necessaria approvazione di m | artedesign
Fabric supplied by customers: must be approved by m | artedesign



1,8 ml



2,5 mq

Cuscino Termosaldato per seduta

Heat sealed seat cushion

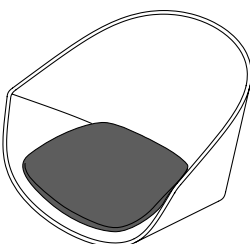

Solo tessuto CHEVRONNE e YUTA NAVY SUPER per cuscino termosaldato
Only CHEVRONNE and YUTA NAVY SUPER fabric for heat-sealed pillow



0,35 ml

Tutti i prodotti rivestiti non sono idonei all'esposizione diretta e prolungata ai raggi solari
Upholstered products are not suitable for direct and prolonged exposure to sunlight

Categorie Categories	Tessuto Fabric	Produttore Manufacturer	Caratteristiche tecniche Technical characteristics
S	BONDAI	Fidivi	100% Polyester
A	ONE SECRET	Fidivi	100% Recycled Polyester
	JET	Flukso	76% PVC - 22% PES - 2% PU
	MINI	Fidivi	100% Polyester Trevira CS
	CURA	Fidivi	100% Polyester Trevira CS
	CURA	Gabriel	98% Post-consumer Recycled Polyester - 2% Polyester
B	SEALIFE	Fidivi	100% Recycled Polyester - SEAQUAL Certified
	GO CHECK	Gabriel	100% Trevira cs
	FOCUS	Gabriel	100% New Zealand Wool
	FOCUS MELANGE	Gabriel	100% New Zealand Wool
	GO UNI	Gabriel	100% Trevira CS
	EXTREMA AU	Flukso	63% PU - 29% COT - 8% PES
	STRETCHY GYRE	Flukso	100% PES FR 100% Revive (PP)
C	ACTON	Vescom	100% Flame-retardant Polyester
	GORGEOUS	Flukso	50% PES FR - 50% TREVIRA® CS
	PASSION	Gabriel	91% New Zealand Wool - 9% Polyamide
	BREEZE FUSION	Gabriel	88% New Zealand Wool - 12% Polyamide
	STRETCHY PG Slis/Anna Viise	Flukso	100% Polyester
D	TEMPT	Gabriel	100% Polyester
	CRISP	Gabriel	93% New Zealand Wool - 7% Polyamide
	WOLIN	Vescom	75% Wool - 20% Polyester - 5% Polyamide
	CLUNIS	Torri Lana	33% Wool - 25% Polyester- 25% PC- 15% CO- 2% PA
	BOEMIAN	Torri Lana	33% Wool - 25% Polyester- 25% PC- 15% CO- 2% PA
	EUROPOST 2 MORPH	Gabriel Gabriel	100% New Zealand Wool 85% New Zealand Wool - 15% Polyamide
E	CANVAS 2	Kvadrat	90% Combed virgin wool - 10 % Nylon
	HALLINGDAL 65	Kvadrat	70% New Wool - 30% Viscose
	FIORD 2	Kvadrat	92% Combed virgin wool - 8% Nylon
	REMIX 3	Kvadrat	90% New Wool Worsted - 10% Nylon
P	PRESCOTT	Mastrotto	100% Bovine
	POLO	Effetigest	100% Bovine origin
Q	LINEA SWEET	Mastrotto Effetigest	100% Bovine 100% Bovine origin



Riciclato
Recycled

Cat. A: One, Cura
Cat. B: Sealife, Gyre
Cat. C: Acton
Cat. D: Wolin



Ignifugo
Flame retardant

Levante

ACCESSORI ACESSORIES



STANDARD STANDARD

Base con inserto in polipropilene per pavimenti duri
Base with polypropylene insert for hard floors



SU RICHIESTA ON REQUEST

Base con inserto per pavimenti delicati
Base with glide for sensitive floors

Imballo 100% riciclabile
100% recyclable packaging



SIMBOLI SYMBOLS



Numero di colli
Number of packages



Pezzi per collo
Pieces per package



Volume in m3
Volume in m3



Peso in kg
Weight in kg



Consumo tessuto (ml)
Fabric consumption (ml)



Consumo pelle (mq)
Leather consumption (mq)

Poltroncina con scocca in polipropilene o rivestita e 4 gambe in acciaio verniciato

Armchair with polypropylene or upholstered shell and 4 legs in varnished alluminium

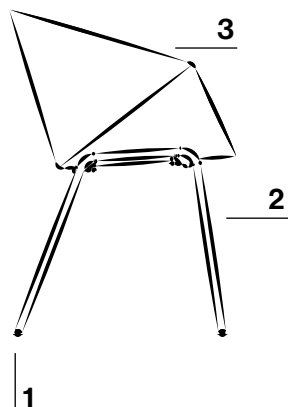
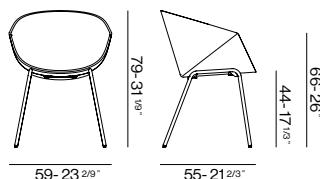

1. Base con inserto in polipropilene per pavimenti duri o delicati
Base with polypropylene insert for hard or delicate floors
2. Struttura metallica in tubo di acciaio al carbonio ad alto spessore. Alta percentuale (max 60,8%) di materiale ferroso riciclato (LEED - NC 2009). Telaio verniciato a polveri termoindurenti a base di resine poliesteri per la prevenzione della proliferazione microbica
Metal structure made of thick carbon steel tube. High percentage (max 60,8%) of recycled ferrous material (LEED - NC 2009). Thermosetting powder-coated frame based on polyester resins to prevent microbial proliferation. Also available with outdoor treatment
3. Scocca in polipropilene proviente al 70% da riciclo post industriale
Polypropylene shell from 70% post-industrial recycling

FINITURE FINISHES

SCocca SHELL

Polipropilene Polypropylene



IG AN NG CB WR PG DG NB

STRUTTURA FRAME

Verniciato a polvere Powder coated



IG AN NG CB WR PG DG NB GO BR

DETTAGLI SPEDIZIONE SHIPMENT DETAILS

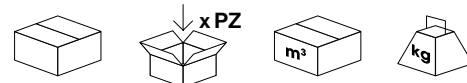

1 1pz 0,35m³ 9kg

Levante

VERSIONE SCOCCA SHELL VERSION

Polipropilene

Polypropylene

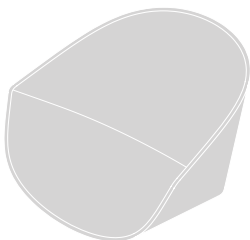

Polipropilene con cuscino fisso

Polypropylene with fixed cushion

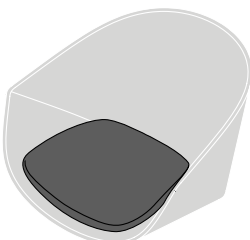

Tessuto cliente: necessaria approvazione di m | artedesign
Fabric supplied by customers: must be approved by m | artedesign



1 ml



1,4 mq

Rivestita totale

Fully upholstered

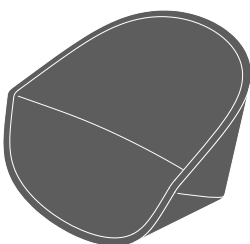

Tessuto cliente: necessaria approvazione di m | artedesign
Fabric supplied by customers: must be approved by m | artedesign



1,8 ml



2,5 mq

Cuscino Termosaldato per seduta

Heat sealed seat cushion

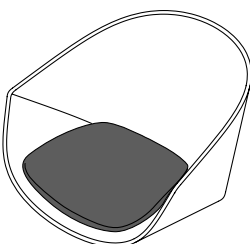

Solo tessuto CHEVRONNE e YUTA NAVY SUPER per cuscino termosaldato
Only CHEVRONNE and YUTA NAVY SUPER fabric for heat-sealed pillow



0,35 ml

Tutti i prodotti rivestiti non sono idonei all'esposizione diretta e prolungata ai raggi solari
Upholstered products are not suitable for direct and prolonged exposure to sunlight

Categorie Categories	Tessuto Fabric	Produttore Manufacturer	Caratteristiche tecniche Technical characteristics
S	BONDAI	Fidivi	100% Polyester
A	ONE	Fidivi	100% Recycled Polyester
	SECRET	Flukso	76% PVC - 22% PES - 2% PU
	JET	Fidivi	100% Polyester Trevira CS
	MINI	Fidivi	100% Polyester Trevira CS
	CURA	Gabriel	98% Post-consumer Recycled Polyester - 2% Polyester
B	SEALIFE	Fidivi	100% Recycled Polyester - SEAQUAL Certified
	GO CHECK	Gabriel	100% Trevira cs
	FOCUS	Gabriel	100% New Zealand Wool
	FOCUS MELANGE	Gabriel	100% New Zealand Wool
	GO UNI	Gabriel	100% Trevira CS
	EXTREMA AU	Flukso	63% PU - 29% COT - 8% PES
	STRETCHY	Flukso	100% PES FR
C	GYRE	Flukso	100% Revive (PP)
	ACTON	Vescom	100% Flame-retardant Polyester
	GORGEOUS	Flukso	50% PES FR - 50% TREVIRA® CS
	PASSION	Gabriel	91% New Zealand Wool - 9% Polyamide
	BREEZE FUSION	Gabriel	88% New Zealand Wool - 12% Polyamide
D	STRETCHY	Flukso	100% Polyester
	PG Slis/Anna Viise TEMPT	Gabriel	100% Polyester
	CRISP	Gabriel	93% New Zealand Wool - 7% Polyamide
	WOLIN	Vescom	75% Wool - 20% Polyester - 5% Polyamide
	CLUNIS	Torri Lana	33% Wool - 25% Polyester- 25% PC- 15% CO- 2% PA
	BOEMIAN	Torri Lana	33% Wool - 25% Polyester- 25% PC- 15% CO- 2% PA
E	EUROPOST 2	Gabriel	100% New Zealand Wool
	MORPH	Gabriel	85% New Zealand Wool - 15% Polyamide
	CANVAS 2	Kvadrat	90% Combed virgin wool - 10 % Nylon
	HALLINGDAL 65	Kvadrat	70% New Wool - 30% Viscose
P	FIORD 2	Kvadrat	92% Combed virgin wool - 8% Nylon
	REMIX 3	Kvadrat	90% New Wool Worsted - 10% Nylon
Q	PRESCOTT	Mastrotto	100% Bovine
	POLO	Effetigest	100% Bovine origin
Q	LINEA	Mastrotto	100% Bovine
	SWEET	Effetigest	100% Bovine origin



Riciclato
Recycled

Cat. A: One, Cura
Cat. B: Sealife, Gyre
Cat. C: Acton
Cat. D: Wolin



Ignifugo
Flame retardant

Levante

ACCESSORI ACESSORIES



STANDARD STANDARD

Base orientabile per struttura 4 Gambe
Swivel base for 4 Legs base



STANDARD STANDARD

Inserto per pavimenti duri
Glide for hard floors



STANDARD STANDARD

inserto intercambiabile per pavimenti delicati
Interchangeable glide for delicate floors

Imballo 100% riciclabile
100% recyclable packaging



SIMBOLI SYMBOLS



Numero di colli
Number of packages



Pezzi per collo
Pieces per package



Volume in m3
Volume in m3



Peso in kg
Weight in kg



Consumo tessuto (ml)
Fabric consumption (ml)



Consumo pelle (mq)
Leather consumption (mq)

Poltroncina con scocca in polipropilene o rivestita e telaio a dondolo in metallo verniciato con pattini in legno massello di faggio

Armchair with polypropylene or upholstered shell and rocking frame in varnished metal with runners in solid beech wood

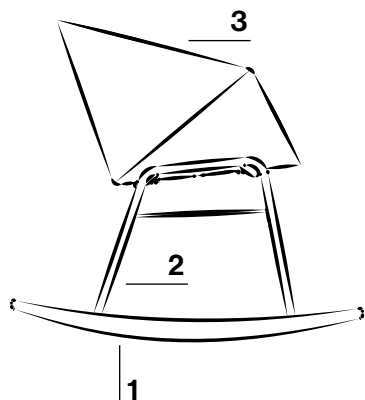
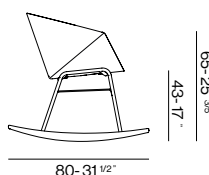
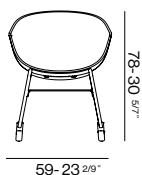

- Pattini in legno massello di faggio Europeo**
European solid beech wood runners
- Telaio a dondolo composto da esterno in tubo di acciaio al carbonio ad alto spessore. Alta percentuale (max 60,8 %) di materiale ferroso riciclato (LEED – NC 2009). Telaio interno in filo di ferro trafilato crudo lucido FE 360 B 12 mm con percentuale media di ferro riciclato del 26,07%. La struttura in acciaio è facilmente disassemblabile**
Rocking frame composed of with thick carbon steel tube outer frame. High percentage (max 60,8 %) of recycled ferrous material (LEED - NC 2009). Inner frame made of FE 360 B 12 mm polished raw drawn iron wire with an average percentage of recycled iron of 26,07%. The steel frame is easily disassembled
- Scocca in polipropilene proveniente al 70% da riciclo post industriale**
Polypropylene shell from 70% post-industrial recycling

FINITURE FINISHES

SCocca SHELL

Polipropilene Polypropylene



STRUTTURA FRAME

Verniciato a polvere Powder coated



COLORI LEGNO PER TRAVERSO WOOD COLORS FOR TRAVERSE

Legno Wood



DETTAGLI SPEDIZIONE SHIPMENT DETAILS

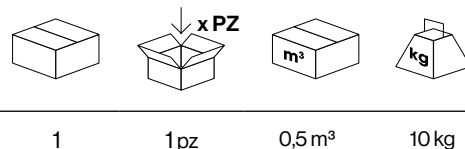

Levante

VERSIONE SCOCCA SHELL VERSION

Polipropilene

Polypropylene

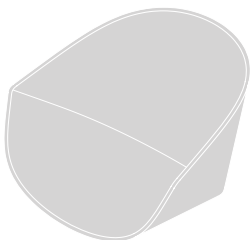

Polipropilene con cuscino fisso

Polypropylene with fixed cushion

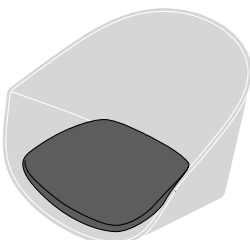

Tessuto cliente: necessaria approvazione di m | artedesign
Fabric supplied by customers: must be approved by m | artedesign



1 ml



1,4 mq

Rivestita totale

Fully upholstered

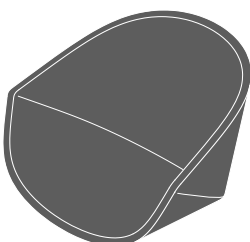

Tessuto cliente: necessaria approvazione di m | artedesign
Fabric supplied by customers: must be approved by m | artedesign



1,8 ml



2,5 mq

Cuscino Termosaldato per seduta

Heat sealed seat cushion

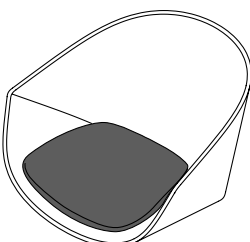

Solo tessuto CHEVRONNE e YUTA NAVY SUPER per cuscino termosaldato
Only CHEVRONNE and YUTA NAVY SUPER fabric for heat-sealed pillow



0,35 ml

Tutti i prodotti rivestiti non sono idonei all'esposizione diretta e prolungata ai raggi solari
Upholstered products are not suitable for direct and prolonged exposure to sunlight

Categorie Categories	Tessuto Fabric	Produttore Manufacturer	Caratteristiche tecniche Technical characteristics
S	BONDAI	Fidivi	100% Polyester
A	ONE	Fidivi	100% Recycled Polyester
	SECRET	Flukso	76% PVC - 22% PES - 2% PU
	JET	Fidivi	100% Polyester Trevira CS
	MINI	Fidivi	100% Polyester Trevira CS
	CURA	Gabriel	98% Post-consumer Recycled Polyester - 2% Polyester
B	SEALIFE	Fidivi	100% Recycled Polyester - SEAQUAL Certified
	GO CHECK	Gabriel	100% Trevira cs
	FOCUS	Gabriel	100% New Zealand Wool
	FOCUS MELANGE	Gabriel	100% New Zealand Wool
	GO UNI	Gabriel	100% Trevira CS
	EXTREMA AU	Flukso	63% PU - 29% COT - 8% PES
	STRETCHY	Flukso	100% PES FR
C	GYRE	Flukso	100% Revive (PP)
	ACTON	Vescom	100% Flame-retardant Polyester
	GORGEOUS	Flukso	50% PES FR - 50% TREVIRA® CS
	PASSION	Gabriel	91% New Zealand Wool - 9% Polyamide
	BREEZE FUSION	Gabriel	88% New Zealand Wool - 12% Polyamide
	STRETCHY PG Slis/Anna Viise	Flukso	100% Polyester
D	TEMPT	Gabriel	100% Polyester
	CRISP	Gabriel	93% New Zealand Wool - 7% Polyamide
	WOLIN	Vescom	75% Wool - 20% Polyester - 5% Polyamide
	CLUNIS	Torri Lana	33% Wool - 25% Polyester- 25% PC- 15% CO- 2% PA
	BOEMIAN	Torri Lana	33% Wool - 25% Polyester- 25% PC- 15% CO- 2% PA
	EUROPOST 2	Gabriel	100% New Zealand Wool
E	MORPH	Gabriel	85% New Zealand Wool - 15% Polyamide
	CANVAS 2	Kvadrat	90% Combed virgin wool - 10 % Nylon
	HALLINGDAL 65	Kvadrat	70% New Wool - 30% Viscose
	FIORD 2	Kvadrat	92% Combed virgin wool - 8% Nylon
P	REMIX 3	Kvadrat	90% New Wool Worsted - 10% Nylon
	PRESCOTT	Mastrotto	100% Bovine
Q	POLO	Effetigest	100% Bovine origin
	LINEA	Mastrotto	100% Bovine
	SWEET	Effetigest	100% Bovine origin



Riciclato
Recycled

Cat. A: One, Cura
Cat. B: Sealife, Gyre
Cat. C: Acton
Cat. D: Wolin



Ignifugo
Flame retardant

Levante

Imballo 100% riciclabile
100% recyclable packaging



SIMBOLI SYMBOLS



Numero di colli
Number of packages



Pezzi per collo
Pieces per package



Volume in m3
Volume in m3



Peso in kg
Weight in kg



Consumo tessuto (ml)
Fabric consumption (ml)



Consumo pelle (mq)
Leather consumption (mq)

Poltroncina con scocca in polipropilene o rivestita e base 4 gambe in legno massello di frassino verniciato

Armchair with polypropylene or upholstered shell and 4 legs in varnished solid ash wood

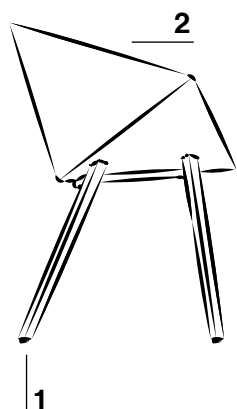
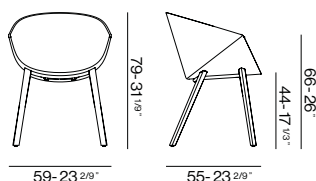

1. Gambe in legno massello di frassino Europeo
European ash wood legs
2. Scocca in polipropilene provientente al 70% da riciclo post industriale
Polypropylene shell from 70% post-industrial recycling

FINITURE FINISHES

SCocca SHELL

Polipropilene Polypropylene



IG AN NG CB WR PG DG NB

STRUTTURA FRAME

Legno Wood



BA NA

DETTAGLI SPEDIZIONE SHIPMENT DETAILS

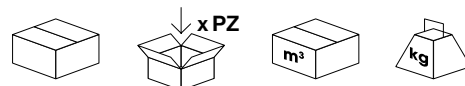

1 1pz 0,35m³ 11,5kg

Levante

VERSIONE SCOCCA SHELL VERSION

Polipropilene

Polypropylene

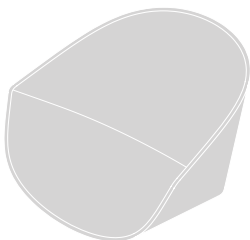

Polipropilene con cuscino fisso

Polypropylene with fixed cushion

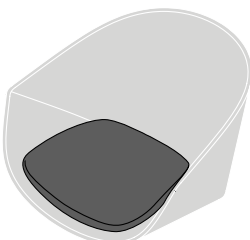

Tessuto cliente: necessaria approvazione di m | artedesign
Fabric supplied by customers: must be approved by m | artedesign



1 ml



1,4 mq

Rivestita totale

Fully upholstered

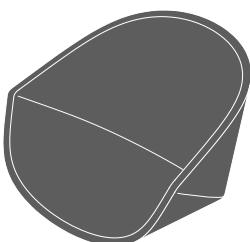

Tessuto cliente: necessaria approvazione di m | artedesign
Fabric supplied by customers: must be approved by m | artedesign



1,8 ml



2,5 mq

Cuscino Termosaldato per seduta

Heat sealed seat cushion

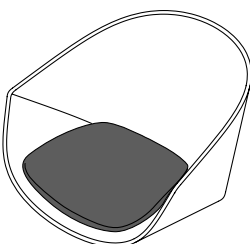

Solo tessuto CHEVRONNE e YUTA NAVY SUPER per cuscino termosaldato
Only CHEVRONNE and YUTA NAVY SUPER fabric for heat-sealed pillow



0,35 ml

Tutti i prodotti rivestiti non sono idonei all'esposizione diretta e prolungata ai raggi solari
Upholstered products are not suitable for direct and prolonged exposure to sunlight

Categorie Categories	Tessuto Fabric	Produttore Manufacturer	Caratteristiche tecniche Technical characteristics
S	BONDAI	Fidivi	100% Polyester
A	ONE	Fidivi	100% Recycled Polyester
	SECRET	Flukso	76% PVC - 22% PES - 2% PU
	JET	Fidivi	100% Polyester Trevira CS
	MINI	Fidivi	100% Polyester Trevira CS
	CURA	Gabriel	98% Post-consumer Recycled Polyester - 2% Polyester
B	SEALIFE	Fidivi	100% Recycled Polyester - SEAQUAL Certified
	GO CHECK	Gabriel	100% Trevira cs
	FOCUS	Gabriel	100% New Zealand Wool
	FOCUS MELANGE	Gabriel	100% New Zealand Wool
	GO UNI	Gabriel	100% Trevira CS
	EXTREMA AU	Flukso	63% PU - 29% COT - 8% PES
	STRETCHY	Flukso	100% PES FR
C	GYRE	Flukso	100% Revive (PP)
	ACTON	Vescom	100% Flame-retardant Polyester
	GORGEOUS	Flukso	50% PES FR - 50% TREVIRA® CS
	PASSION	Gabriel	91% New Zealand Wool - 9% Polyamide
	BREEZE FUSION	Gabriel	88% New Zealand Wool - 12% Polyamide
D	STRETCHY	Flukso	100% Polyester
	PG Slis/Anna Viise TEMPT	Gabriel	100% Polyester
	CRISP	Gabriel	93% New Zealand Wool - 7% Polyamide
	WOLIN	Vescom	75% Wool - 20% Polyester - 5% Polyamide
	CLUNIS	Torri Lana	33% Wool - 25% Polyester- 25% PC- 15% CO- 2% PA
E	BOEMIAN	Torri Lana	33% Wool - 25% Polyester- 25% PC- 15% CO- 2% PA
	EUROPOST 2	Gabriel	100% New Zealand Wool
	MORPH	Gabriel	85% New Zealand Wool - 15% Polyamide
	CANVAS 2	Kvadrat	90% Combed virgin wool - 10 % Nylon
P	HALLINGDAL 65	Kvadrat	70% New Wool - 30% Viscose
	FIORD 2	Kvadrat	92% Combed virgin wool - 8% Nylon
	REMIX 3	Kvadrat	90% New Wool Worsted - 10% Nylon
Q	PRESCOTT	Mastrotto	100% Bovine
	POLO	Effetigest	100% Bovine origin
P	LINEA	Mastrotto	100% Bovine
	SWEET	Effetigest	100% Bovine origin



Riciclato
Recycled

Cat. A: One, Cura
Cat. B: Sealife, Gyre
Cat. C: Acton
Cat. D: Wolin



Ignifugo
Flame retardant

Levante

ACCESSORI ACESSORIES

WAGNER
design yourself

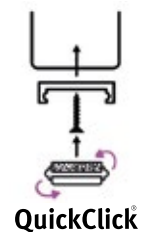

STANDARD STANDARD

Base rotonda per telaio in legno
Round base for wooden frame



STANDARD STANDARD

Inserto per pavimenti duri
Glide for hard floors



SU RICHIESTA ON REQUEST

inserto intercambiabile per pavimenti delicati
Interchangeable glide for delicate floors

Imballo 100% riciclabile
100% recyclable packaging



SIMBOLI SYMBOLS



Numero di colli
Number of packages



Pezzi per collo
Pieces per package



Volume in m3
Volume in m3



Peso in kg
Weight in kg



Consumo tessuto (ml)
Fabric consumption (ml)



Consumo pelle (mq)
Leather consumption (mq)

Poltroncina con scocca in polipropilene o rivestita e base girevole 5 razze "Office" in alluminio verniciato con alzata a gas

Armchair with polypropylene or upholstered shell and 5 star swivel "Office" base in varnished aluminium with gas lift

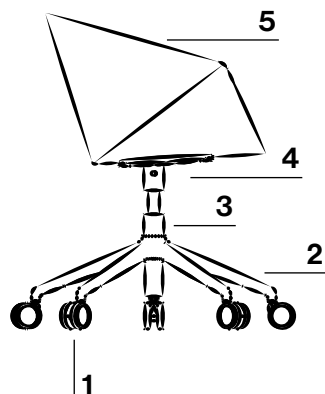
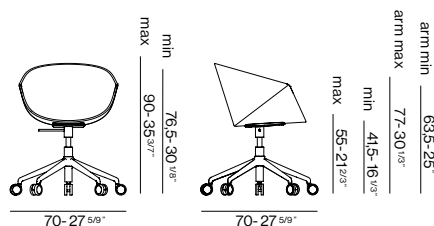

- Ruote Ø 65 mm in copolimero rinforzato e fasce di rotolamento morbide**
Ø 65 mm reinforced copolymer castors with soft rolling treads
- Base a cinque razze in alluminio verniciata a polveri termoindurenti a base di resine poliesteri per la prevenzione della proliferazione microbica**
Five-star aluminium base painted with polyester resin-based thermosetting powders to prevent microbial proliferation
- Pistone a gas**
Gas piston
- Supporto fisso con piastra di fissaggio e regolazione in altezza tramite leva**
Fixed support with fixing plate and height adjustment by lever
- Scocca in polipropilene proveniente al 70% da riciclo post industriale**
Polypropylene shell from 70% post-industrial recycling

FINITURE FINISHES

SCocca SHELL

Polipropilene Polypropylene



IG AN NG CB WR PG DG NB

STRUTTURA FRAME

Verniciato a polvere Powder coated



IG AN NG CB WR PG DG NB GO BR

DETTAGLI SPEDIZIONE SHIPMENT DETAILS

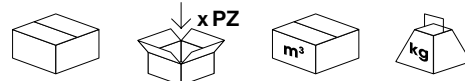

1 1pz 0,4 m³ 12kg

Levante

VERSIONE SCOCCA SHELL VERSION

Polipropilene

Polypropylene

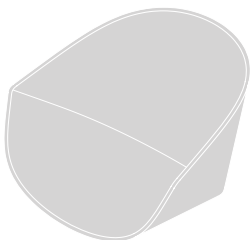

Polipropilene con cuscino fisso

Polypropylene with fixed cushion

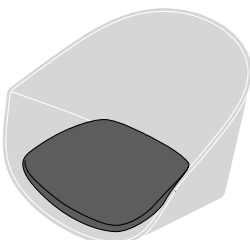

Tessuto cliente: necessaria approvazione di m | artedesign
Fabric supplied by customers: must be approved by m | artedesign



1 ml



1,4 mq

Rivestita totale

Fully upholstered

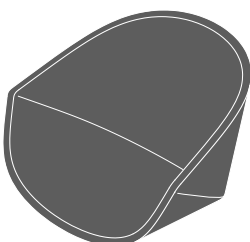

Tessuto cliente: necessaria approvazione di m | artedesign
Fabric supplied by customers: must be approved by m | artedesign



1,8 ml



2,5 mq

Cuscino Termosaldato per seduta

Heat sealed seat cushion

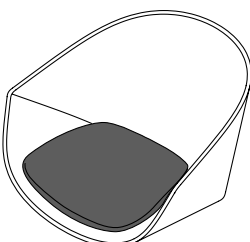

Solo tessuto CHEVRONNE e YUTA NAVY SUPER per cuscino termosaldato
Only CHEVRONNE and YUTA NAVY SUPER fabric for heat-sealed pillow



0,35 ml

Tutti i prodotti rivestiti non sono idonei all'esposizione diretta e prolungata ai raggi solari
Upholstered products are not suitable for direct and prolonged exposure to sunlight

Categorie Categories	Tessuto Fabric	Produttore Manufacturer	Caratteristiche tecniche Technical characteristics
S	BONDAI	Fidivi	100% Polyester
A	ONE SECRET	Fidivi	100% Recycled Polyester
	JET	Flukso	76% PVC - 22% PES - 2% PU
	MINI	Fidivi	100% Polyester Trevira CS
	CURA	Fidivi	100% Polyester Trevira CS
	CURA	Gabriel	98% Post-consumer Recycled Polyester - 2% Polyester
B	SEALIFE	Fidivi	100% Recycled Polyester - SEAQUAL Certified
	GO CHECK	Gabriel	100% Trevira cs
	FOCUS	Gabriel	100% New Zealand Wool
	FOCUS MELANGE	Gabriel	100% New Zealand Wool
	GO UNI	Gabriel	100% Trevira CS
	EXTREMA AU	Flukso	63% PU - 29% COT - 8% PES
	STRETCHY	Flukso	100% PES FR
C	GYRE	Flukso	100% Revive (PP)
	ACTON	Vescom	100% Flame-retardant Polyester
	GORGEOUS	Flukso	50% PES FR - 50% TREVIRA® CS
	PASSION	Gabriel	91% New Zealand Wool - 9% Polyamide
	BREEZE FUSION	Gabriel	88% New Zealand Wool - 12% Polyamide
D	STRETCHY	Flukso	100% Polyester
	PG Slis/Anna Viise		
	TEMPT	Gabriel	100% Polyester
	CRISP	Gabriel	93% New Zealand Wool - 7% Polyamide
	WOLIN	Vescom	75% Wool - 20% Polyester - 5% Polyamide
E	CLUNIS	Torri Lana	33% Wool - 25% Polyester- 25% PC- 15% CO- 2% PA
	BOEMIAN	Torri Lana	33% Wool - 25% Polyester- 25% PC- 15% CO- 2% PA
	EUROPOST 2	Gabriel	100% New Zealand Wool
	MORPH	Gabriel	85% New Zealand Wool - 15% Polyamide
P	CANVAS 2	Kvadrat	90% Combed virgin wool - 10 % Nylon
	HALLINGDAL 65	Kvadrat	70% New Wool - 30% Viscose
	FIORD 2	Kvadrat	92% Combed virgin wool - 8% Nylon
	REMIX 3	Kvadrat	90% New Wool Worsted - 10% Nylon
Q	PRESCOTT	Mastrotto	100% Bovine
	POLO	Effetigest	100% Bovine origin
Q	LINEA	Mastrotto	100% Bovine
	SWEET	Effetigest	100% Bovine origin



Riciclato
Recycled

Cat. A: One, Cura
Cat. B: Sealife, Gyre
Cat. C: Acton
Cat. D: Wolin



Ignifugo
Flame retardant

Levante

ACCESSORI ACESSORIES

STANDARD STANDARD



Ruota nera d. 65 mm in copolimero rinforzato con fasce di rotolamento morbide; battistrada idoneo per pavimenti normali

Black castor d. 65 mm reinforced copolymer soft treads; suitable for normal floors

STANDARD STANDARD



Ruota bianca d. 65 mm in copolimero rinforzato con fasce di rotolamento morbide; battistrada idoneo per pavimenti normali

White castor d. 65 mm reinforced copolymer soft treads; suitable for normal floors

Imballo 100% riciclabile
100% recyclable packaging



SIMBOLI SYMBOLS



Numero di colli
Number of packages



Pezzi per collo
Pieces per package



Volume in m3
Volume in m3



Peso in kg
Weight in kg



Consumo tessuto (ml)
Fabric consumption (ml)



Consumo pelle (mq)
Leather consumption (mq)



Seduta girevole
Swivel seat



Alzata a gas
Gas lift

Poltroncina con scocca in polipropilene o rivestita e base girevole 4 razze "Office" in alluminio verniciato

Armchair with polypropylene or upholstered shell and 4 star swivel "Office" base in varnished aluminium

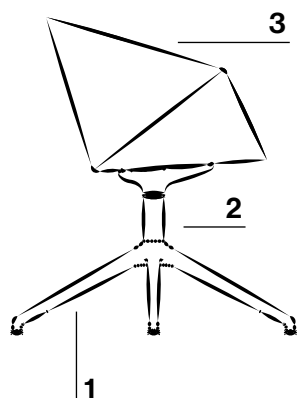
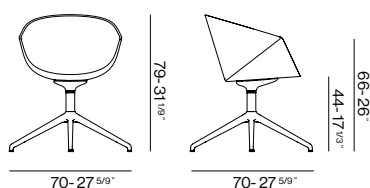

1. Base a quattro razze in alluminio verniciata a polveri termoindurenti a base di resine poliestere per la prevenzione della proliferazione microbica. Protezioni per pavimenti con inserti in polipropilene intercambiabili per superfici dure o delicate
Four-star aluminium base painted with polyester resin-based thermosetting powders to prevent microbial proliferation. Floor protectors with interchangeable polypropylene glides for hard or delicate surfaces
2. Supporto fisso con piastra di fissaggio
Fixed support with fixing plate
3. Scocca in polipropilene provientente al 70% da riciclo post industriale
Polypropylene shell from 70% post-industrial recycling

FINITURE FINISHES

SCocca SHELL

Polipropilene Polypropylene



IG AN NG CB WR PG DG NB

STRUTTURA FRAME

Verniciato a polvere Powder coated



IG AN NG CB WR PG DG NB GO BR

DETTAGLI SPEDIZIONE SHIPMENT DETAILS

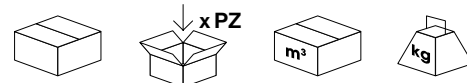

1 1pz 0,35m³ 10,5kg

Levante

VERSIONE SCOCCA SHELL VERSION

Polipropilene

Polypropylene

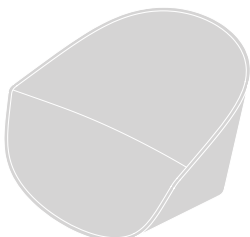

Polipropilene con cuscino fisso

Polypropylene with fixed cushion

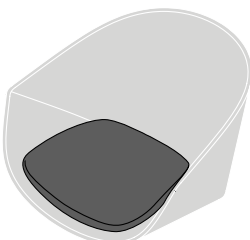

Tessuto cliente: necessaria approvazione di m | artedesign
Fabric supplied by customers: must be approved by m | artedesign



1 ml



1,4 mq

Rivestita totale

Fully upholstered

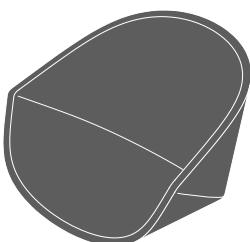

Tessuto cliente: necessaria approvazione di m | artedesign
Fabric supplied by customers: must be approved by m | artedesign



1,8 ml



2,5 mq

Cuscino Termosaldato per seduta

Heat sealed seat cushion

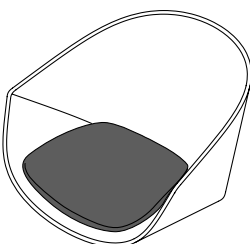

Solo tessuto CHEVRONNE e YUTA NAVY SUPER per cuscino termosaldato
Only CHEVRONNE and YUTA NAVY SUPER fabric for heat-sealed pillow



0,35 ml

Tutti i prodotti rivestiti non sono idonei all'esposizione diretta e prolungata ai raggi solari
Upholstered products are not suitable for direct and prolonged exposure to sunlight

Categorie Categories	Tessuto Fabric	Produttore Manufacturer	Caratteristiche tecniche Technical characteristics
S	BONDAI	Fidivi	100% Polyester
A	ONE SECRET	Fidivi	100% Recycled Polyester
	JET	Flukso	76% PVC - 22% PES - 2% PU
	MINI	Fidivi	100% Polyester Trevira CS
	CURA	Fidivi	100% Polyester Trevira CS
	CURA	Gabriel	98% Post-consumer Recycled Polyester - 2% Polyester
B	SEALIFE	Fidivi	100% Recycled Polyester - SEAQUAL Certified
	GO CHECK	Gabriel	100% Trevira cs
	FOCUS	Gabriel	100% New Zealand Wool
	FOCUS MELANGE	Gabriel	100% New Zealand Wool
	GO UNI	Gabriel	100% Trevira CS
	EXTREMA AU	Flukso	63% PU - 29% COT - 8% PES
	STRETCHY	Flukso	100% PES FR
C	GYRE	Flukso	100% Revive (PP)
	ACTON	Vescom	100% Flame-retardant Polyester
	GORGEOUS	Flukso	50% PES FR - 50% TREVIRA® CS
	PASSION	Gabriel	91% New Zealand Wool - 9% Polyamide
	BREEZE FUSION	Gabriel	88% New Zealand Wool - 12% Polyamide
D	STRETCHY	Flukso	100% Polyester
	TEMPT	Gabriel	100% Polyester
	CRISP	Gabriel	93% New Zealand Wool - 7% Polyamide
	WOLIN	Vescom	75% Wool - 20% Polyester - 5% Polyamide
	CLUNIS	Torri Lana	33% Wool - 25% Polyester- 25% PC- 15% CO- 2% PA
E	BOEMIAN	Torri Lana	33% Wool - 25% Polyester- 25% PC- 15% CO- 2% PA
	EUROPOST 2	Gabriel	100% New Zealand Wool
	MORPH	Gabriel	85% New Zealand Wool - 15% Polyamide
	CANVAS 2	Kvadrat	90% Combed virgin wool - 10 % Nylon
P	HALLINGDAL 65	Kvadrat	70% New Wool - 30% Viscose
	FIORD 2	Kvadrat	92% Combed virgin wool - 8% Nylon
	REMIX 3	Kvadrat	90% New Wool Worsted - 10% Nylon
Q	PRESCOTT	Mastrotto	100% Bovine
	POLO	Effetigest	100% Bovine origin
P	LINEA	Mastrotto	100% Bovine
	SWEET	Effetigest	100% Bovine origin



Riciclato
Recycled

Cat. A: One, Cura
Cat. B: Sealife, Gyre
Cat. C: Acton
Cat. D: Wolin



Ignifugo
Flame retardant

Levante

ACCESSORI ACESSORIES

WAGNER
design yourself

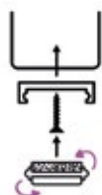

QuickClick



Base per struttura 4 razze "Office"
Base for 4 star base "Office"



Inserto intercambiabile per pavimenti delicati
Interchangeable glide for delicate floors

Imballo 100% riciclabile
100% recyclable packaging



SIMBOLI SYMBOLS



Numero di colli
Number of packages



Pezzi per collo
Pieces per package



Volume in m3
Volume in m3



Peso in kg
Weight in kg



Consumo tessuto (ml)
Fabric consumption (ml)



Consumo pelle (mq)
Leather consumption (mq)



Seduta girevole
Swivel seat

Poltroncina con scocca in polipropilene o rivestita e base fissa 4 razze "Office" in alluminio verniciato con ruote

Armchair with polypropylene or upholstered shell and 4 star fixed "Office" base in varnished aluminium with castors

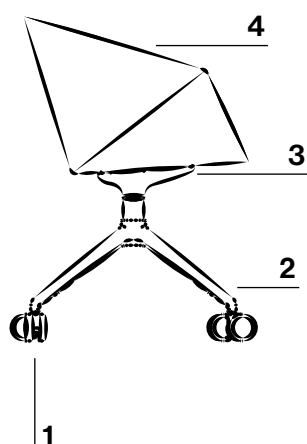
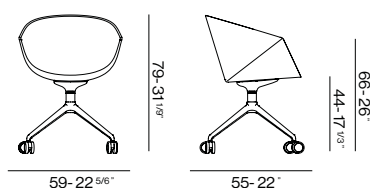

1. Ruote Ø 65 mm in copolimero rinforzato e fasce di rotolamento morbide
Ø 65 mm reinforced copolymer castors with soft rolling treads
2. Base a quattro razze in alluminio verniciata a polveri termoindurenti a base di resine poliestere per la prevenzione della proliferazione microbica
Four-star aluminium base painted with polyester resin-based thermosetting powders to prevent microbial proliferation
3. Supporto fisso con piastra di fissaggio
Fixed support with fixing plate
4. Scocca in polipropilene provientente al 70% da riciclo post industriale
Polypropylene shell from 70% post-industrial recycling

FINITURE FINISHES

SCocca SHELL

Polipropilene Polypropylene



IG AN NG CB WR PG DG NB

STRUTTURA FRAME

Verniciato a polvere Powder coated



IG AN NG CB WR PG DG NB GO BR

DETTAGLI SPEDIZIONE SHIPMENT DETAILS

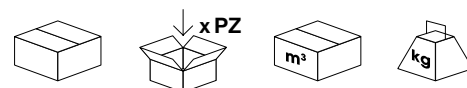

1 1pz 0,35m³ 10kg

Levante

VERSIONE SCOCCA SHELL VERSION

Polipropilene

Polypropylene

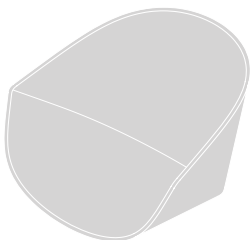

Polipropilene con cuscino fisso

Polypropylene with fixed cushion

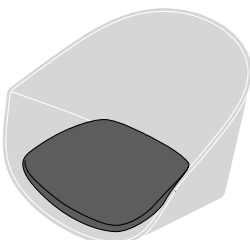

Tessuto cliente: necessaria approvazione di m | artedesign
Fabric supplied by customers: must be approved by m | artedesign



1 ml



1,4 mq

Rivestita totale

Fully upholstered

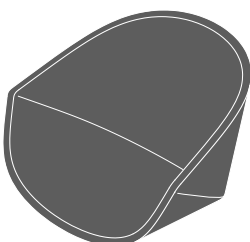

Tessuto cliente: necessaria approvazione di m | artedesign
Fabric supplied by customers: must be approved by m | artedesign



1,8 ml



2,5 mq

Cuscino Termosaldato per seduta

Heat sealed seat cushion

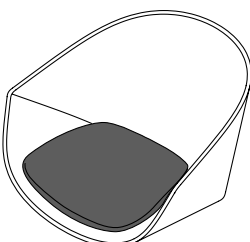

Solo tessuto CHEVRONNE e YUTA NAVY SUPER per cuscino termosaldato
Only CHEVRONNE and YUTA NAVY SUPER fabric for heat-sealed pillow



0,35 ml

Tutti i prodotti rivestiti non sono idonei all'esposizione diretta e prolungata ai raggi solari
Upholstered products are not suitable for direct and prolonged exposure to sunlight

Categorie Categories	Tessuto Fabric	Produttore Manufacturer	Caratteristiche tecniche Technical characteristics
S	BONDAI	Fidivi	100% Polyester
A	ONE	Fidivi	100% Recycled Polyester
	SECRET	Flukso	76% PVC - 22% PES - 2% PU
	JET	Fidivi	100% Polyester Trevira CS
	MINI	Fidivi	100% Polyester Trevira CS
	CURA	Gabriel	98% Post-consumer Recycled Polyester - 2% Polyester
B	SEALIFE	Fidivi	100% Recycled Polyester - SEAQUAL Certified
	GO CHECK	Gabriel	100% Trevira cs
	FOCUS	Gabriel	100% New Zealand Wool
	FOCUS MELANGE	Gabriel	100% New Zealand Wool
	GO UNI	Gabriel	100% Trevira CS
	EXTREMA AU	Flukso	63% PU - 29% COT - 8% PES
	STRETCHY	Flukso	100% PES FR
C	GYRE	Flukso	100% Revive (PP)
	ACTON	Vescom	100% Flame-retardant Polyester
	GORGEOUS	Flukso	50% PES FR - 50% TREVIRA® CS
	PASSION	Gabriel	91% New Zealand Wool - 9% Polyamide
	BREEZE FUSION	Gabriel	88% New Zealand Wool - 12% Polyamide
D	STRETCHY	Flukso	100% Polyester
	PG Slis/Anna Viise TEMPT	Gabriel	100% Polyester
	CRISP	Gabriel	93% New Zealand Wool - 7% Polyamide
	WOLIN	Vescom	75% Wool - 20% Polyester - 5% Polyamide
	CLUNIS	Torri Lana	33% Wool - 25% Polyester- 25% PC- 15% CO- 2% PA
E	BOEMIAN	Torri Lana	33% Wool - 25% Polyester- 25% PC- 15% CO- 2% PA
	EUROPOST 2	Gabriel	100% New Zealand Wool
	MORPH	Gabriel	85% New Zealand Wool - 15% Polyamide
	CANVAS 2	Kvadrat	90% Combed virgin wool - 10 % Nylon
P	HALLINGDAL 65	Kvadrat	70% New Wool - 30% Viscose
	FIORD 2	Kvadrat	92% Combed virgin wool - 8% Nylon
	REMIX 3	Kvadrat	90% New Wool Worsted - 10% Nylon
Q	PRESCOTT	Mastrotto	100% Bovine
	POLO	Effetigest	100% Bovine origin
P	LINEA	Mastrotto	100% Bovine
	SWEET	Effetigest	100% Bovine origin



Riciclato
Recycled

Cat. A: One, Cura
Cat. B: Sealife, Gyre
Cat. C: Acton
Cat. D: Wolin



Ignifugo
Flame retardant

STANDARD STANDARD



Ruota nera d. 65 mm in copolimero rinforzato con fasce di rotolamento morbide; battistrada idoneo per pavimenti normali

Black castor d. 65 mm reinforced copolymer soft treads; suitable for normal floors

STANDARD STANDARD



Ruota bianca d. 65 mm in copolimero rinforzato con fasce di rotolamento morbide; battistrada idoneo per pavimenti normali

White castor d. 65 mm reinforced copolymer soft treads; suitable for normal floors

Imballo 100% riciclabile
100% recyclable packaging



SIMBOLI SYMBOLS



Numero di colli
Number of packages



Pezzi per collo
Pieces per package



Volume in m3
Volume in m3



Peso in kg
Weight in kg



Consumo tessuto (ml)
Fabric consumption (ml)



Consumo pelle (mq)
Leather consumption (mq)

