

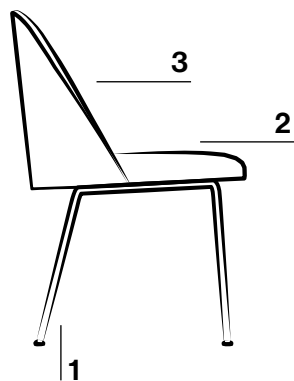

## Sedia rivestita con scocca in legno curvato impiallacciato in rovere e 4 gambe in acciaio verniciato

Upholstered chair with curved oak wood veneered shell and 4 legs in varnished steel

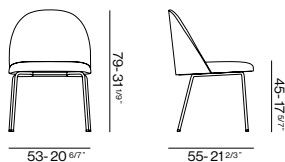

1. **Struttura metallica in tubo di acciaio al carbonio ad alto spessore. Alta percentuale (max 60,8%) di materiale ferroso riciclato (LEED - NC 2009). Telaio verniciato a polveri termoindurenti a base di resine poliestere per la prevenzione della proliferazione microbica**  
Metal structure made of thick carbon steel tube. High percentage (max 60,8%) of recycled ferrous material (LEED - NC 2009). Thermosetting powder-coated frame based on polyester resins to prevent microbial proliferation. Also available with outdoor treatment
2. **Sedile e fronte schienale imbottiti con poliuretano espanso**  
Seat and front back padded with polyurethane foam
3. **Scocca in legno curvato, impiallacciata esternamente per la versione rivestita anteriore e tappezzata interamente per la versione rivestita totale**  
Curved wooden shell, veneered externally for the front-covered version and fully upholstered for the fully upholstered version

### FINITURE FINISHES

#### SCocca SHELL

Legno Wood



BO NO

#### STRUTTURA FRAME

Verniciato a polvere Powder coated

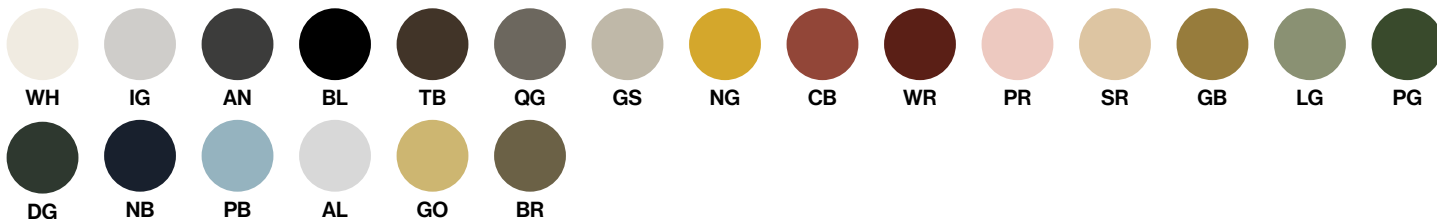

### DETTAGLI SPEDIZIONE SHIPMENT DETAILS

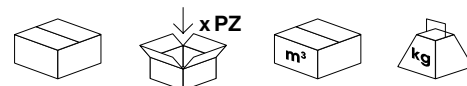

1 1pz 0,35m<sup>3</sup> 10 kg

# Seile

## VERSIONE SCOCCA SHELL VERSION

### Rivestita Anteriore

Frontal Upholstered

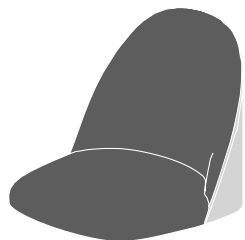

Tessuto cliente: necessaria approvazione di m | artedesign  
Fabric supplied by customers: must be approved by m | artedesign



0,65 ml



0,92 mq

### Rivestita Totale

Fully Upholstered

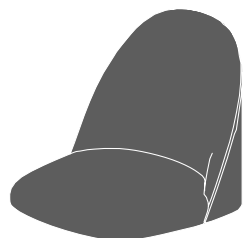

Tessuto cliente: necessaria approvazione di m | artedesign  
Fabric supplied by customers: must be approved by m | artedesign



1,2 ml



1,68 mq

### Rivestita Anteriore più Second Skin

Frontal Upholstered and Second Skin

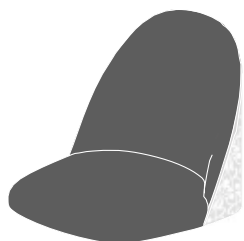

Tessuto cliente: necessaria approvazione di m | artedesign  
Fabric supplied by customers: must be approved by m | artedesign



Impianto grafico su disegno cliente una tantum  
Graphic custom design one-off payment



0,65 ml



0,92 mq

Tutti i prodotti rivestiti non sono idonei all'esposizione diretta e prolungata ai raggi solari  
Upholstered products are not suitable for direct and prolonged exposure to sunlight

Categorie Categories	Tessuto Fabric	Produttore Manufacturer	Caratteristiche tecniche Technical characteristics
<b>S</b>	<b>BONDAI</b>	Fidivi	100% Polyester
<b>A</b>	<b>ONE SECRET</b>	Fidivi	100% Recycled Polyester
	<b>JET</b>	Flukso	76% PVC - 22% PES - 2% PU
	<b>MINI</b>	Fidivi	100% Polyester Trevira CS
	<b>CURA</b>	Fidivi	100% Polyester Trevira CS
		Gabriel	98% Post-consumer Recycled Polyester - 2% Polyester
<b>B</b>	<b>SEALIFE</b>	Fidivi	100% Recycled Polyester - SEAQUAL Certified
	<b>GO CHECK</b>	Gabriel	100% Trevira cs
	<b>FOCUS</b>	Gabriel	100% New Zealand Wool
	<b>FOCUS MELANGE</b>	Gabriel	100% New Zealand Wool
	<b>GO UNI</b>	Gabriel	100% Trevira CS
	<b>EXTREMA AU</b>	Flukso	63% PU - 29% COT - 8% PES
	<b>STRETCHY GYRE</b>	Flukso	100% PES FR 100% Revive (PP)
<b>C</b>	<b>ACTON</b>	Vescom	100% Flame-retardant Polyester
	<b>GORGEOUS</b>	Flukso	50% PES FR - 50% TREVIRA® CS
	<b>PASSION</b>	Gabriel	91% New Zealand Wool - 9% Polyamide
	<b>BREEZE FUSION</b>	Gabriel	88% New Zealand Wool - 12% Polyamide
	<b>STRETCHY</b> PG Slis/Anna Viise	Flukso	100% Polyester
	<b>TEMPT</b>	Gabriel	100% Polyester
<b>D</b>	<b>CRISP</b>	Gabriel	93% New Zealand Wool - 7% Polyamide
	<b>WOLIN</b>	Vescom	75% Wool - 20% Polyester - 5% Polyamide
	<b>CLUNIS</b>	Torri Lana	33% Wool - 25% Polyester- 25% PC- 15% CO- 2% PA
	<b>BOEMIAN</b>	Torri Lana	33% Wool - 25% Polyester- 25% PC- 15% CO- 2% PA
	<b>EUROPOST 2</b>	Gabriel	100% New Zealand Wool
	<b>MORPH</b>	Gabriel	85% New Zealand Wool - 15% Polyamide
<b>E</b>	<b>CANVAS 2</b>	Kvadrat	90% Combed virgin wool - 10 % Nylon
	<b>HALLINGDAL 65</b>	Kvadrat	70% New Wool - 30% Viscose
	<b>FIORD 2</b>	Kvadrat	92% Combed virgin wool - 8% Nylon
	<b>REMIX 3</b>	Kvadrat	90% New Wool Worsted - 10% Nylon
<b>P</b>	<b>PRESCOTT</b>	Mastrotto	100% Bovine
	<b>POLO</b>	Effetigest	100% Bovine origin
<b>Q</b>	<b>LINEA</b>	Mastrotto	100% Bovine
	<b>SWEET</b>	Effetigest	100% Bovine origin



Riciclato  
Recycled

**Cat. A:** One, Cura  
**Cat. B:** Sealife, Gyre  
**Cat. C:** Acton  
**Cat. D:** Wolin



Ignifugo  
Flame retardant

## SECOND SKIN SECOND SKIN



**01 Barocco**  
01 Baroque



**02 Koi**  
02 Koi



**03 Fiore**  
03 Flower



**04 Autunno**  
04 Autumn



**05 Orchidea**  
05 Orchid



**06 Orientale**  
06 Oriental



**07 Intreccio**  
07 Plot



**08 Voodoo**  
08 Voodoo



STANDARD STANDARD

Base orientabile per struttura 4 Gambe  
Swivel base for 4 Legs base



STANDARD STANDARD

Inserto per pavimenti duri  
Glide for hard floors



STANDARD STANDARD

Inserto intercambiabile per pavimenti delicati  
Interchangeable glide for delicate floors

Imballo 100% riciclabile  
100% recyclable packaging



## SIMBOLI SYMBOLS



**Numero di colli**  
Number of packages



**Pezzi per collo**  
Pieces per package



**Volume in m3**  
Volume in m3



**Peso in kg**  
Weight in kg



**Consumo tessuto (ml)**  
Fabric consumption (ml)



**Consumo pelle (mq)**  
Leather consumption (mq)

## Sedia rivestita con scocca in legno curvato impiallacciato in rovere e 4 gambe in acciaio verniciato

Upholstered chair with curved oak wood veneered shell and 4 legs in varnished steel

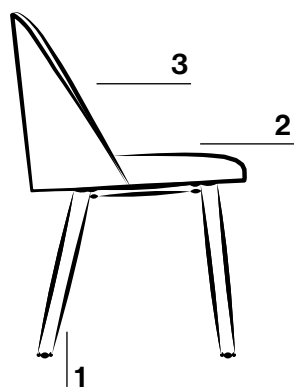
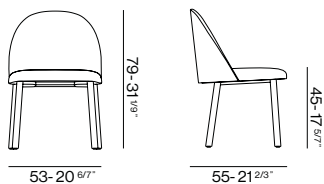

1. Gambe in legno massello di frassino Europeo  
European solid ash wood legs
2. Sedile e fronte schienale imbottiti con poliuretano espanso  
Seat and front back padded with polyurethane foam
3. Scocca in legno curvato, impiallacciata esternamente per la versione rivestita anteriore e tappezzata interamente per la versione rivestita totale  
Curved wooden shell, veneered externally for the front-covered version and fully upholstered for the fully upholstered version

### FINITURE FINISHES

#### SCocca SHELL

Legno Wood



BO NO

#### STRUTTURA FRAME

Verniciato a polvere Powder coated



BA NA

### DETTAGLI SPEDIZIONE SHIPMENT DETAILS

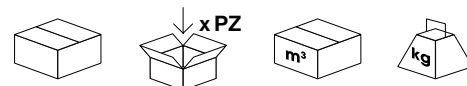

1 1pz 0,35m<sup>3</sup> 12kg

# Seile

## VERSIONE SCOCCA SHELL VERSION

### Rivestita Anteriore

Frontal Upholstered

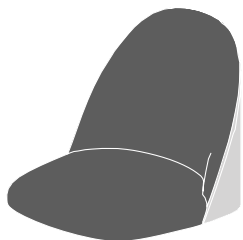

Tessuto cliente: necessaria approvazione di m | artedesign  
Fabric supplied by customers: must be approved by m | artedesign



0,65 ml



0,92 mq

### Rivestita Totale

Fully Upholstered

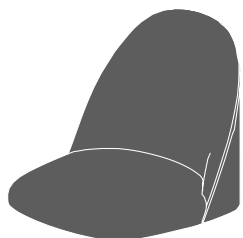

Tessuto cliente: necessaria approvazione di m | artedesign  
Fabric supplied by customers: must be approved by m | artedesign



1,2 ml



1,68 mq

### Rivestita Anteriore più Second Skin

Frontal Upholstered and Second Skin

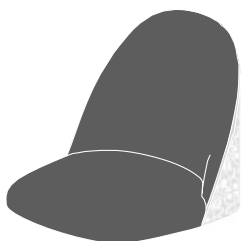

Tessuto cliente: necessaria approvazione di m | artedesign  
Fabric supplied by customers: must be approved by m | artedesign



Impianto grafico su disegno cliente una tantum  
Graphic custom design one-off payment



0,65 ml



0,92 mq

Tutti i prodotti rivestiti non sono idonei all'esposizione diretta e prolungata ai raggi solari

Upholstered products are not suitable for direct and prolonged exposure to sunlight

Categorie Categories	Tessuto Fabric	Produttore Manufacturer	Caratteristiche tecniche Technical characteristics
<b>S</b>	<b>BONDAI</b>	Fidivi	100% Polyester
<b>A</b>	<b>ONE SECRET</b>	Fidivi	100% Recycled Polyester
	<b>JET</b>	Flukso	76% PVC - 22% PES - 2% PU
	<b>MINI</b>	Fidivi	100% Polyester Trevira CS
	<b>CURA</b>	Fidivi	100% Polyester Trevira CS
	<b>CURA</b>	Gabriel	98% Post-consumer Recycled Polyester - 2% Polyester
<b>B</b>	<b>SEALIFE</b>	Fidivi	100% Recycled Polyester - SEAQUAL Certified
	<b>GO CHECK</b>	Gabriel	100% Trevira cs
	<b>FOCUS</b>	Gabriel	100% New Zealand Wool
	<b>FOCUS MELANGE</b>	Gabriel	100% New Zealand Wool
	<b>GO UNI</b>	Gabriel	100% Trevira CS
	<b>EXTREMA AU</b>	Flukso	63% PU - 29% COT - 8% PES
	<b>STRETCHY</b>	Flukso	100% PES FR
<b>C</b>	<b>GYRE</b>	Flukso	100% Revive (PP)
	<b>ACTON</b>	Vescom	100% Flame-retardant Polyester
	<b>GORGEOUS</b>	Flukso	50% PES FR - 50% TREVIRA® CS
	<b>PASSION</b>	Gabriel	91% New Zealand Wool - 9% Polyamide
	<b>BREEZE FUSION</b>	Gabriel	88% New Zealand Wool - 12% Polyamide
	<b>STRETCHY</b>	Flukso	100% Polyester
<b>D</b>	PG Slis/Anna Viise <b>TEMPT</b>	Gabriel	100% Polyester
	<b>CRISP</b>	Gabriel	93% New Zealand Wool - 7% Polyamide
	<b>WOLIN</b>	Vescom	75% Wool - 20% Polyester - 5% Polyamide
	<b>CLUNIS</b>	Torri Lana	33% Wool - 25% Polyester- 25% PC- 15% CO- 2% PA
	<b>BOEMIAN</b>	Torri Lana	33% Wool - 25% Polyester- 25% PC- 15% CO- 2% PA
	<b>EUROPOST 2</b>	Gabriel	100% New Zealand Wool
<b>E</b>	<b>MORPH</b>	Gabriel	85% New Zealand Wool - 15% Polyamide
	<b>CANVAS 2</b>	Kvadrat	90% Combed virgin wool - 10 % Nylon
	<b>HALLINGDAL 65</b>	Kvadrat	70% New Wool - 30% Viscose
	<b>FIORD 2</b>	Kvadrat	92% Combed virgin wool - 8% Nylon
	<b>REMIX 3</b>	Kvadrat	90% New Wool Worsted - 10% Nylon
<b>P</b>	<b>PRESCOTT</b>	Mastrotto	100% Bovine
	<b>POLO</b>	Effetigest	100% Bovine origin
<b>Q</b>	<b>LINEA SWEET</b>	Mastrotto	100% Bovine
		Effetigest	100% Bovine origin



Riciclato  
Recycled

**Cat. A:** One, Cura  
**Cat. B:** Sealife, Gyre  
**Cat. C:** Acton  
**Cat. D:** Wolin



Ignifugo  
Flame retardant

## SECOND SKIN SECOND SKIN



**01 Barocco**  
01 Baroque



**02 Koi**  
02 Koi



**03 Fiore**  
03 Flower



**04 Autunno**  
04 Autumn



**05 Orchidea**  
05 Orchid



**06 Orientale**  
06 Oriental



**07 Intreccio**  
07 Plot



**08 Voodoo**  
08 Voodoo



# Seile

## ACCESSORI ACCESSORIES

**WAGNER**  
design yourself

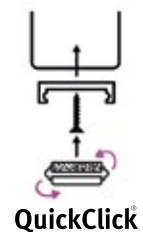

**STANDARD STANDARD**

**Base rotonda per telaio in legno**  
Round base for wooden frame



**STANDARD STANDARD**

**Inserto per pavimenti duri**  
Glide for hard floors



**SU RICHIESTA ON REQUEST**

**inserto intercambiabile per pavimenti delicati**  
Interchangeable glide for delicate floors

**Imballo 100% riciclabile**  
100% recyclable packaging



## SIMBOLI SYMBOLS



**Numero di colli**  
Number of packages



**Pezzi per collo**  
Pieces per package



**Volume in m3**  
Volume in m3



**Peso in kg**  
Weight in kg



**Consumo tessuto (ml)**  
Fabric consumption (ml)



**Consumo pelle (mq)**  
Leather consumption (mq)

## Sedia rivestita con scocca in legno curvato impiallacciato in rovere e base girevole 5 razze "Office Q" in alluminio verniciato con alzata a gas

Upholstered chair with curved oak wood veneered shell and 5 star swivel "Office Q" base in varnished aluminium base with gas lift

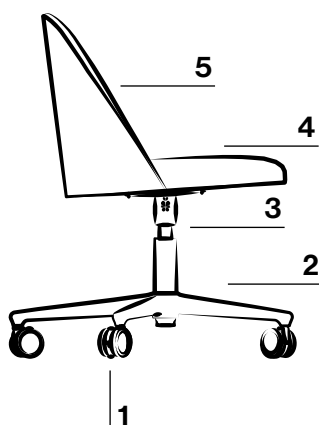
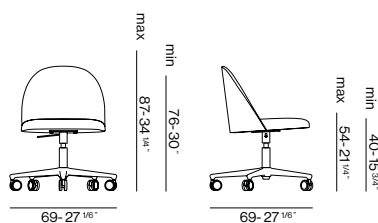

1. Ruote Ø 65 mm in copolimero rinforzato e fasce di rotolamento morbide  
Ø 65 mm reinforced copolymer castors with soft rolling treads
2. Base a cinque razze in alluminio verniciata a polveri termoindurenti a base di resine poliestere per la prevenzione della proliferazione microbica  
Five-star aluminium base painted with polyester resin-based thermosetting powders to prevent microbial proliferation
3. Pistone a gas  
Gas lift
4. Sedile e fronte schienale imbottiti con poliuretano espanso  
Seat and front back padded with polyurethane foam
5. Scocca in legno curvato, impiallacciata esternamente per la versione rivestita anteriore e tappezzata interamente per la versione rivestita totale  
Curved wooden shell, veneered externally for the front-covered version and fully upholstered for the fully upholstered version

### FINITURE FINISHES

#### SCocca SHELL

Legno Wood



BO NO

#### STRUTTURA FRAME

Verniciato a polvere Powder coated

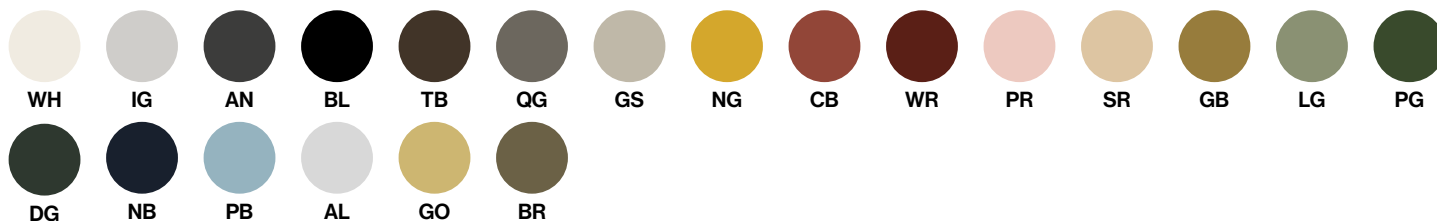

### DETTAGLI SPEDIZIONE SHIPMENT DETAILS

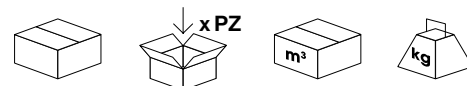

1 1pz 0,4 m<sup>3</sup> 13 kg

# Seile

## VERSIONE SCOCCA SHELL VERSION

### Rivestita Anteriore

Frontal Upholstered

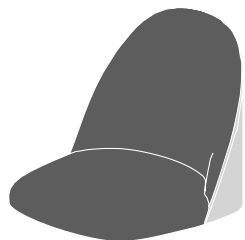

Tessuto cliente: necessaria approvazione di m | artedesign  
Fabric supplied by customers: must be approved by m | artedesign



0,65 ml



0,92 mq

### Rivestita Totale

Fully Upholstered

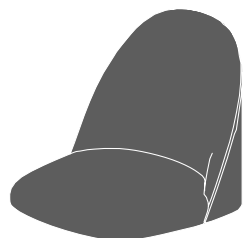

Tessuto cliente: necessaria approvazione di m | artedesign  
Fabric supplied by customers: must be approved by m | artedesign



1,2 ml



1,68 mq

### Rivestita Anteriore più Second Skin

Frontal Upholstered and Second Skin

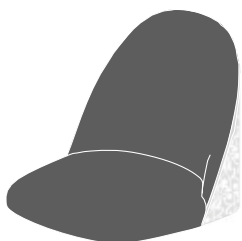

Tessuto cliente: necessaria approvazione di m | artedesign  
Fabric supplied by customers: must be approved by m | artedesign



Impianto grafico su disegno cliente una tantum  
Graphic custom design one-off payment



0,65 ml



0,92 mq

Tutti i prodotti rivestiti non sono idonei all'esposizione diretta e prolungata ai raggi solari  
Upholstered products are not suitable for direct and prolonged exposure to sunlight

Categorie Categories	Tessuto Fabric	Produttore Manufacturer	Caratteristiche tecniche Technical characteristics
<b>S</b>	<b>BONDAI</b>	Fidivi	100% Polyester
<b>A</b>	<b>ONE SECRET</b>	Fidivi	100% Recycled Polyester
	<b>JET</b>	Flukso	76% PVC - 22% PES - 2% PU
	<b>MINI</b>	Fidivi	100% Polyester Trevira CS
	<b>CURA</b>	Fidivi	100% Polyester Trevira CS
	<b>CURA</b>	Gabriel	98% Post-consumer Recycled Polyester - 2% Polyester
<b>B</b>	<b>SEALIFE</b>	Fidivi	100% Recycled Polyester - SEAQUAL Certified
	<b>GO CHECK</b>	Gabriel	100% Trevira cs
	<b>FOCUS</b>	Gabriel	100% New Zealand Wool
	<b>FOCUS MELANGE</b>	Gabriel	100% New Zealand Wool
	<b>GO UNI</b>	Gabriel	100% Trevira CS
	<b>EXTREMA AU</b>	Flukso	63% PU - 29% COT - 8% PES
	<b>STRETCHY GYRE</b>	Flukso	100% PES FR 100% Revive (PP)
<b>C</b>	<b>ACTON</b>	Vescom	100% Flame-retardant Polyester
	<b>GORGEOUS</b>	Flukso	50% PES FR - 50% TREVIRA® CS
	<b>PASSION</b>	Gabriel	91% New Zealand Wool - 9% Polyamide
	<b>BREEZE FUSION</b>	Gabriel	88% New Zealand Wool - 12% Polyamide
	<b>STRETCHY</b> PG Slis/Anna Viise	Flukso	100% Polyester
<b>D</b>	<b>TEMPT</b>	Gabriel	100% Polyester
	<b>CRISP</b>	Gabriel	93% New Zealand Wool - 7% Polyamide
	<b>WOLIN</b>	Vescom	75% Wool - 20% Polyester - 5% Polyamide
	<b>CLUNIS</b>	Torri Lana	33% Wool - 25% Polyester- 25% PC- 15% CO- 2% PA
	<b>BOEMIAN</b>	Torri Lana	33% Wool - 25% Polyester- 25% PC- 15% CO- 2% PA
	<b>EUROPOST 2 MORPH</b>	Gabriel Gabriel	100% New Zealand Wool 85% New Zealand Wool - 15% Polyamide
<b>E</b>	<b>CANVAS 2</b>	Kvadrat	90% Combed virgin wool - 10 % Nylon
	<b>HALLINGDAL 65</b>	Kvadrat	70% New Wool - 30% Viscose
	<b>FIORD 2</b>	Kvadrat	92% Combed virgin wool - 8% Nylon
	<b>REMIX 3</b>	Kvadrat	90% New Wool Worsted - 10% Nylon
<b>P</b>	<b>PRESCOTT</b>	Mastrotto	100% Bovine
	<b>POLO</b>	Effetigest	100% Bovine origin
<b>Q</b>	<b>LINEA SWEET</b>	Mastrotto Effetigest	100% Bovine 100% Bovine origin



Riciclato  
Recycled

**Cat. A:** One, Cura  
**Cat. B:** Sealife, Gyre  
**Cat. C:** Acton  
**Cat. D:** Wolin



Ignifugo  
Flame retardant

## SECOND SKIN SECOND SKIN



**01 Barocco**  
01 Baroque



**02 Koi**  
02 Koi



**03 Fiore**  
03 Flower



**04 Autunno**  
04 Autumn



**05 Orchidea**  
05 Orchid



**06 Orientale**  
06 Oriental



**07 Intreccio**  
07 Plot



**08 Voodoo**  
08 Voodoo



### STANDARD STANDARD

Ruota nera d. 65 mm in copolimero rinforzato con fasce di rotolamento morbide; battistrada idoneo per pavimenti normali

Black castor d. 65 mm reinforced copolymer soft treads; suitable for normal floors



### STANDARD STANDARD

Ruota bianca d. 65 mm in copolimero rinforzato con fasce di rotolamento morbide; battistrada idoneo per pavimenti normali

White castor d. 65 mm reinforced copolymer soft treads; suitable for normal floors

Imballo 100% riciclabile  
100% recyclable packaging



## SIMBOLI SYMBOLS



**Numero di colli**  
Number of packages



**Pezzi per collo**  
Pieces per package



**Volume in m3**  
Volume in m3



**Peso in kg**  
Weight in kg



**Consumo tessuto (ml)**  
Fabric consumption (ml)



**Consumo pelle (mq)**  
Leather consumption (mq)



**Seduta girevole**  
Swivel seat



**Alzata a gas**  
Gas lift

## Sedia rivestita con scocca in legno curvato impiallacciato in rovere e base girevole 4 razze "Office Q" in alluminio verniciato

Upholstered chair with curved oak wood veneered shell and 4 star swivel "Office Q" base in varnished aluminium

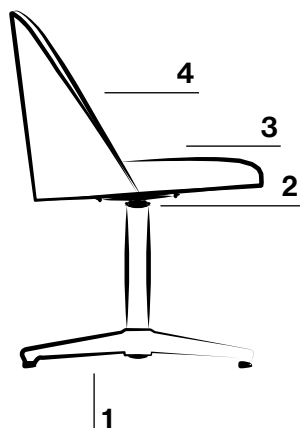
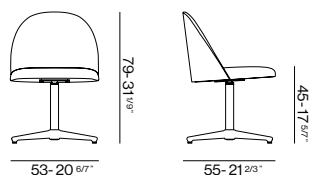

1. Base a cinque razze in alluminio verniciata a polveri termoindurenti a base di resine poliestere per la prevenzione della proliferazione microbica  
Five-star aluminium base painted with polyester resin-based thermosetting powders to prevent microbial proliferation
2. Supporto fisso con piastra di fissaggio  
Fixed support with fixing plate
3. Sedile e fronte schienale imbottiti con poliuretano espanso  
Seat and front back padded with polyurethane foam
4. Scocca in legno curvato, impiallacciata esternamente per la versione rivestita anteriore e tappezzata interamente per la versione rivestita totale  
Curved wooden shell, veneered externally for the front-covered version and fully upholstered for the fully upholstered version

## FINITURE FINISHES

### SCocca SHELL

Legno Wood



BO NO

### STRUTTURA FRAME

Verniciato a polvere Powder coated

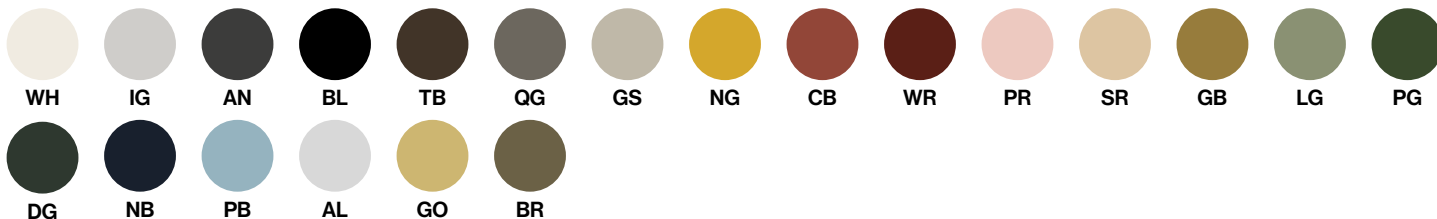

## DETTAGLI SPEDIZIONE SHIPMENT DETAILS

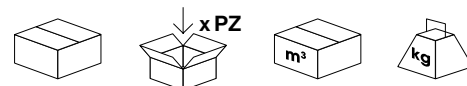

1 1pz 0,35m<sup>3</sup> 12kg

# Seile

## VERSIONE SCOCCA SHELL VERSION

### Rivestita Anteriore

Frontal Upholstered

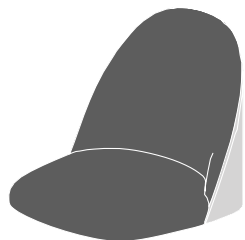

Tessuto cliente: necessaria approvazione di m | artedesign  
Fabric supplied by customers: must be approved by m | artedesign



0,65 ml



0,92 mq

### Rivestita Totale

Fully Upholstered

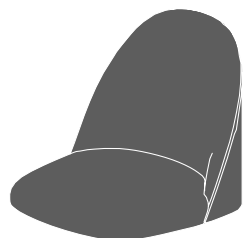

Tessuto cliente: necessaria approvazione di m | artedesign  
Fabric supplied by customers: must be approved by m | artedesign



1,2 ml



1,68 mq

### Rivestita Anteriore più Second Skin

Frontal Upholstered and Second Skin

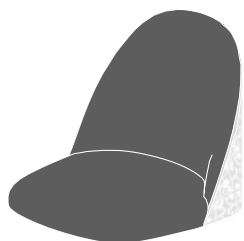

Tessuto cliente: necessaria approvazione di m | artedesign  
Fabric supplied by customers: must be approved by m | artedesign



Impianto grafico su disegno cliente una tantum  
Graphic custom design one-off payment



0,65 ml



0,92 mq

Tutti i prodotti rivestiti non sono idonei all'esposizione diretta e prolungata ai raggi solari  
Upholstered products are not suitable for direct and prolonged exposure to sunlight

Categorie Categories	Tessuto Fabric	Produttore Manufacturer	Caratteristiche tecniche Technical characteristics
<b>S</b>	<b>BONDAI</b>	Fidivi	100% Polyester
<b>A</b>	<b>ONE SECRET</b>	Fidivi	100% Recycled Polyester
	<b>JET</b>	Flukso	76% PVC - 22% PES - 2% PU
	<b>MINI</b>	Fidivi	100% Polyester Trevira CS
	<b>CURA</b>	Fidivi	100% Polyester Trevira CS
	<b>CURA</b>	Gabriel	98% Post-consumer Recycled Polyester - 2% Polyester
<b>B</b>	<b>SEALIFE</b>	Fidivi	100% Recycled Polyester - SEAQUAL Certified
	<b>GO CHECK</b>	Gabriel	100% Trevira cs
	<b>FOCUS</b>	Gabriel	100% New Zealand Wool
	<b>FOCUS MELANGE</b>	Gabriel	100% New Zealand Wool
	<b>GO UNI</b>	Gabriel	100% Trevira CS
	<b>EXTREMA AU</b>	Flukso	63% PU - 29% COT - 8% PES
	<b>STRETCHY</b>	Flukso	100% PES FR
<b>C</b>	<b>GYRE</b>	Flukso	100% Revive (PP)
	<b>ACTON</b>	Vescom	100% Flame-retardant Polyester
	<b>GORGEOUS</b>	Flukso	50% PES FR - 50% TREVIRA® CS
	<b>PASSION</b>	Gabriel	91% New Zealand Wool - 9% Polyamide
	<b>BREEZE FUSION</b>	Gabriel	88% New Zealand Wool - 12% Polyamide
	<b>STRETCHY</b>	Flukso	100% Polyester
	PG Slis/Anna Viise		
	<b>TEMPT</b>	Gabriel	100% Polyester
<b>D</b>	<b>CRISP</b>	Gabriel	93% New Zealand Wool - 7% Polyamide
	<b>WOLIN</b>	Vescom	75% Wool - 20% Polyester - 5% Polyamide
	<b>CLUNIS</b>	Torri Lana	33% Wool - 25% Polyester- 25% PC- 15% CO- 2% PA
	<b>BOEMIAN</b>	Torri Lana	33% Wool - 25% Polyester- 25% PC- 15% CO- 2% PA
	<b>EUROPOST 2</b>	Gabriel	100% New Zealand Wool
	<b>MORPH</b>	Gabriel	85% New Zealand Wool - 15% Polyamide
<b>E</b>	<b>CANVAS 2</b>	Kvadrat	90% Combed virgin wool - 10 % Nylon
	<b>HALLINGDAL 65</b>	Kvadrat	70% New Wool - 30% Viscose
	<b>FIORD 2</b>	Kvadrat	92% Combed virgin wool - 8% Nylon
	<b>REMIX 3</b>	Kvadrat	90% New Wool Worsted - 10% Nylon
<b>P</b>	<b>PRESCOTT</b>	Mastrotto	100% Bovine
	<b>POLO</b>	Effetigest	100% Bovine origin
<b>Q</b>	<b>LINEA</b>	Mastrotto	100% Bovine
	<b>SWEET</b>	Effetigest	100% Bovine origin



Riciclato  
Recycled

**Cat. A:** One, Cura  
**Cat. B:** Sealife, Gyre  
**Cat. C:** Acton  
**Cat. D:** Wolin



Ignifugo  
Flame retardant

## SECOND SKIN SECOND SKIN



**01 Barocco**  
01 Baroque



**02 Koi**  
02 Koi



**03 Fiore**  
03 Flower



**04 Autunno**  
04 Autumn



**05 Orchidea**  
05 Orchid



**06 Orientale**  
06 Oriental



**07 Intreccio**  
07 Plot



**08 Voodoo**  
08 Voodoo



# Seile

ACCESSORI ACESSORIES

**WAGNER**  
design yourself

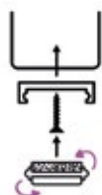

**QuickClick**



**Base per struttura 4 razze "Office"**  
Base for 4 star base "Office"



**Inserto intercambiabile per pavimenti delicati**  
Interchangeable glide for delicate floors

Imballo 100% riciclabile  
100% recyclable packaging



## SIMBOLI SYMBOLS



**Numero di colli**  
Number of packages



**Pezzi per collo**  
Pieces per package



**Volume in m3**  
Volume in m3



**Peso in kg**  
Weight in kg



**Consumo tessuto (ml)**  
Fabric consumption (ml)



**Consumo pelle (mq)**  
Leather consumption (mq)



**Seduta girevole**  
Swivel seat

## Sedia rivestita con scocca in legno curvato impiallacciato in rovere e base fissa 4 razze "Office Q" in alluminio verniciato con ruote

Upholstered chair with oak curved wood veneered shell and 4 star fixed "Office Q" base in varnished aluminium with castors

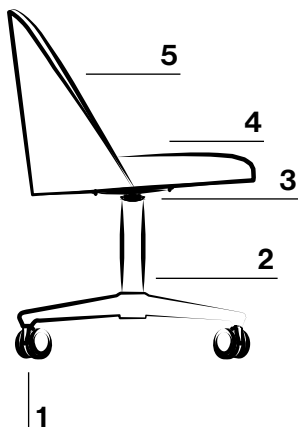
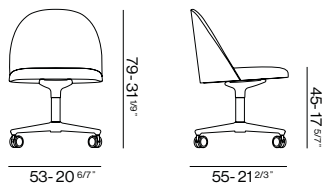

1. Ruote Ø 65 mm in copolimero rinforzato e fasce di rotolamento morbide  
 Ø 65 mm reinforced copolymer castors with soft rolling treads
2. Base a quattro razze in alluminio verniciata a polveri termoindurenti a base di resine poliestere per la prevenzione della proliferazione microbica  
 Four-star aluminium base painted with polyester resin-based thermosetting powders to prevent microbial proliferation
3. Supporto fisso con piastra di fissaggio  
 Fixed support with fixing plate
4. Sedile e fronte schienale imbottiti con poliuretano espanso  
 Seat and front back padded with polyurethane foam
5. Scocca in legno curvato, impiallacciata esternamente per la versione rivestita anteriore e tappezzata interamente per la versione rivestita totale  
 Curved wooden shell, veneered externally for the front-covered version and fully upholstered for the fully upholstered version

## FINITURE FINISHES

### SCocca SHELL

Legno Wood



BO NO

### STRUTTURA FRAME

Verniciato a polvere Powder coated

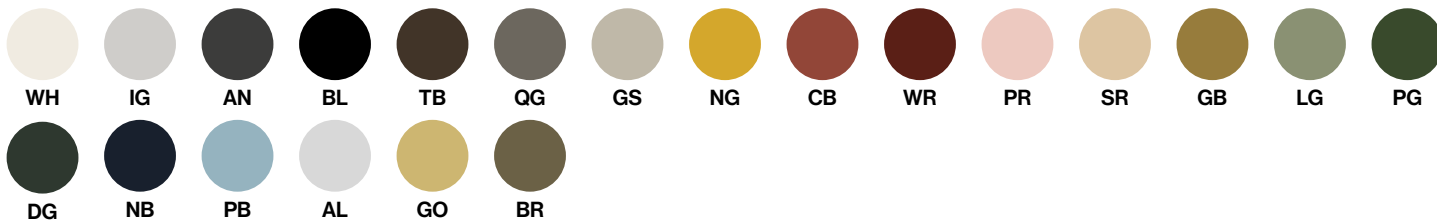

## DETTAGLI SPEDIZIONE SHIPMENT DETAILS

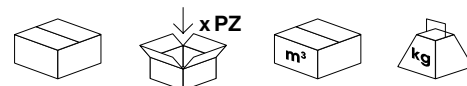

1 1pz 0,35m<sup>3</sup> 12kg

# Seile

## VERSIONE SCOCCA SHELL VERSION

### Rivestita Anteriore

Frontal Upholstered

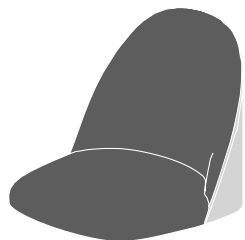

Tessuto cliente: necessaria approvazione di m | artedesign  
Fabric supplied by customers: must be approved by m | artedesign



0,65 ml



0,92 mq

### Rivestita Totale

Fully Upholstered

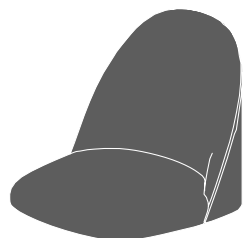

Tessuto cliente: necessaria approvazione di m | artedesign  
Fabric supplied by customers: must be approved by m | artedesign



1,2 ml



1,68 mq

### Rivestita Anteriore più Second Skin

Frontal Upholstered and Second Skin

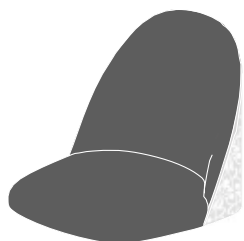

Tessuto cliente: necessaria approvazione di m | artedesign  
Fabric supplied by customers: must be approved by m | artedesign



Impianto grafico su disegno cliente una tantum  
Graphic custom design one-off payment



0,65 ml



0,92 mq

Tutti i prodotti rivestiti non sono idonei all'esposizione diretta e prolungata ai raggi solari

Upholstered products are not suitable for direct and prolonged exposure to sunlight

Categorie Categories	Tessuto Fabric	Produttore Manufacturer	Caratteristiche tecniche Technical characteristics
<b>S</b>	<b>BONDAI</b>	Fidivi	100% Polyester
<b>A</b>	<b>ONE SECRET</b>	Fidivi	100% Recycled Polyester
	<b>JET</b>	Flukso	76% PVC - 22% PES - 2% PU
	<b>MINI</b>	Fidivi	100% Polyester Trevira CS
	<b>CURA</b>	Fidivi	100% Polyester Trevira CS
		Gabriel	98% Post-consumer Recycled Polyester - 2% Polyester
<b>B</b>	<b>SEALIFE</b>	Fidivi	100% Recycled Polyester - SEAQUAL Certified
	<b>GO CHECK</b>	Gabriel	100% Trevira cs
	<b>FOCUS</b>	Gabriel	100% New Zealand Wool
	<b>FOCUS MELANGE</b>	Gabriel	100% New Zealand Wool
	<b>GO UNI</b>	Gabriel	100% Trevira CS
	<b>EXTREMA AU</b>	Flukso	63% PU - 29% COT - 8% PES
	<b>STRETCHY GYRE</b>	Flukso	100% PES FR 100% Revive (PP)
<b>C</b>	<b>ACTON</b>	Vescom	100% Flame-retardant Polyester
	<b>GORGEOUS</b>	Flukso	50% PES FR - 50% TREVIRA® CS
	<b>PASSION</b>	Gabriel	91% New Zealand Wool - 9% Polyamide
	<b>BREEZE FUSION</b>	Gabriel	88% New Zealand Wool - 12% Polyamide
	<b>STRETCHY</b> PG Slis/Anna Viise	Flukso	100% Polyester
	<b>TEMPT</b>	Gabriel	100% Polyester
<b>D</b>	<b>CRISP</b>	Gabriel	93% New Zealand Wool - 7% Polyamide
	<b>WOLIN</b>	Vescom	75% Wool - 20% Polyester - 5% Polyamide
	<b>CLUNIS</b>	Torri Lana	33% Wool - 25% Polyester- 25% PC- 15% CO- 2% PA
	<b>BOEMIAN</b>	Torri Lana	33% Wool - 25% Polyester- 25% PC- 15% CO- 2% PA
	<b>EUROPOST 2</b>	Gabriel	100% New Zealand Wool
	<b>MORPH</b>	Gabriel	85% New Zealand Wool - 15% Polyamide
<b>E</b>	<b>CANVAS 2</b>	Kvadrat	90% Combed virgin wool - 10 % Nylon
	<b>HALLINGDAL 65</b>	Kvadrat	70% New Wool - 30% Viscose
	<b>FIORD 2</b>	Kvadrat	92% Combed virgin wool - 8% Nylon
	<b>REMIX 3</b>	Kvadrat	90% New Wool Worsted - 10% Nylon
<b>P</b>	<b>PRESCOTT</b>	Mastrotto	100% Bovine
	<b>POLO</b>	Effetigest	100% Bovine origin
<b>Q</b>	<b>LINEA</b>	Mastrotto	100% Bovine
	<b>SWEET</b>	Effetigest	100% Bovine origin



Riciclato  
Recycled

**Cat. A:** One, Cura  
**Cat. B:** Sealife, Gyre  
**Cat. C:** Acton  
**Cat. D:** Wolin



Ignifugo  
Flame retardant

## SECOND SKIN SECOND SKIN



**01 Barocco**  
01 Baroque



**02 Koi**  
02 Koi



**03 Fiore**  
03 Flower



**04 Autunno**  
04 Autumn



**05 Orchidea**  
05 Orchid



**06 Orientale**  
06 Oriental



**07 Intreccio**  
07 Plot



**08 Voodoo**  
08 Voodoo

### STANDARD STANDARD



Ruota nera d. 65 mm in copolimero rinforzato con fasce di rotolamento morbide; battistrada idoneo per pavimenti normali

Black castor d. 65 mm reinforced copolymer soft treads; suitable for normal floors

### STANDARD STANDARD



Ruota bianca d. 65 mm in copolimero rinforzato con fasce di rotolamento morbide; battistrada idoneo per pavimenti normali

White castor d. 65 mm reinforced copolymer soft treads; suitable for normal floors

Imballo 100% riciclabile  
100% recyclable packaging



## SIMBOLI SYMBOLS



**Numero di colli**  
Number of packages



**Pezzi per collo**  
Pieces per package



**Volume in m3**  
Volume in m3



**Peso in kg**  
Weight in kg



**Consumo tessuto (ml)**  
Fabric consumption (ml)



**Consumo pelle (mq)**  
Leather consumption (mq)

